



HENRY PARK PRIMARY SCHOOL
SEMESTRAL ASSESSMENT 1 2022

PRIMARY 4

SCIENCE

SECTION A (56 MARKS)

INSTRUCTIONS TO CANDIDATES

1. Do not turn over this page until you are told to do so.
2. Follow all instructions carefully.
3. Answer all questions.
4. Shade your answers on the Optical Answer Sheet (OAS) provided.

Name: _____ ()

Class: Primary 4 ()

Date: 12 May 2022

Total Time for Booklets A and B: 1 h 45 min

Sections	Marks
A	/ 56
B	/ 44
Total	/ 100

Parent's Signature: _____

Section A (56 marks)

For each question from 1 to 28, four options are given. One of them is the correct answer. Make your choice (1, 2, 3 or 4). Shade the correct oval (1, 2, 3 or 4) on the Optical Answer Sheet.

1. Mrs Tan has a dog. When Mrs Tan throws a ball, the dog runs after it.

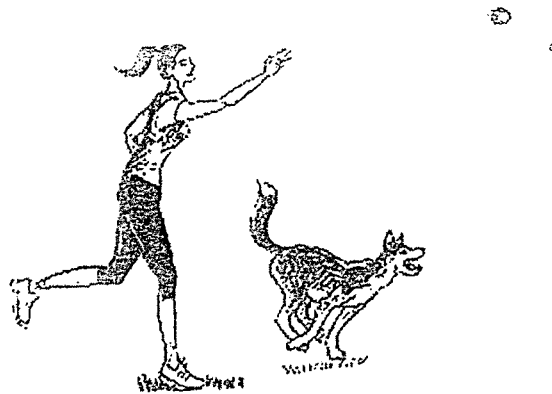

Based on the information given, what characteristic(s) of living things do/does the dog show?

- A It can grow.
- B It can reproduce.
- C It can respond to changes.

- (1) C only
- (2) A and B only
- (3) B and C only
- (4) A, B and C

2. Study the flowchart below.

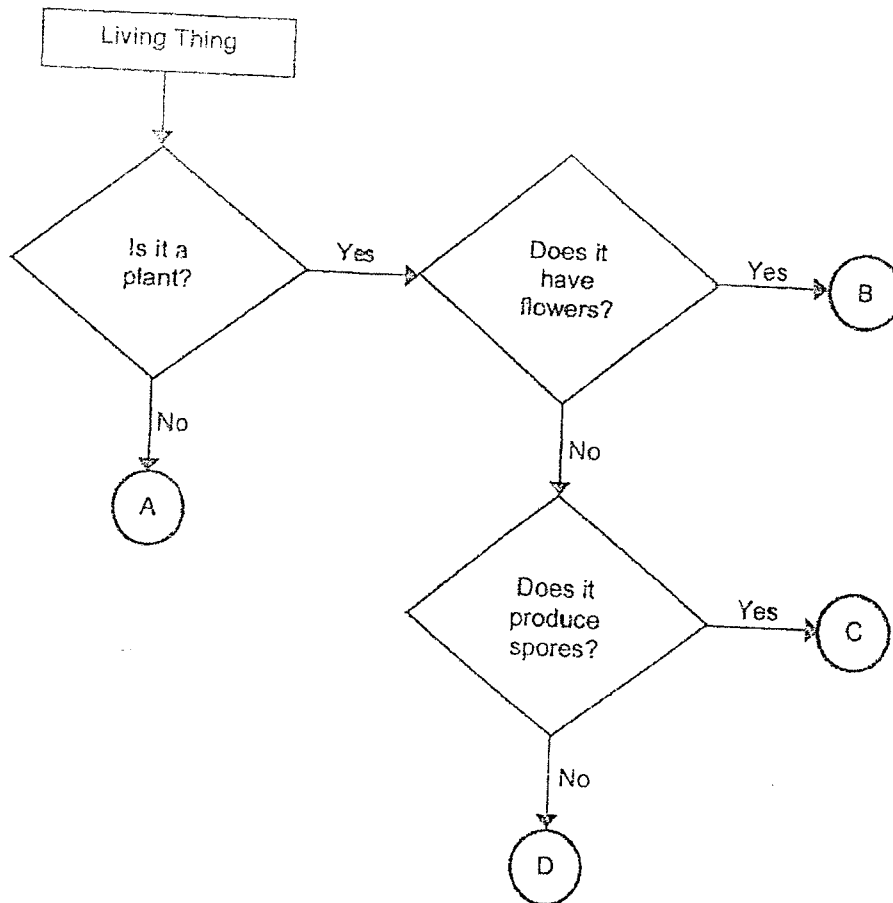

Which of the letters, A, B, C or D, best describes a bird's nest fern?

- (1) A
- (2) B
- (3) C
- (4) D

3. The diagram below shows the life cycle of an animal.

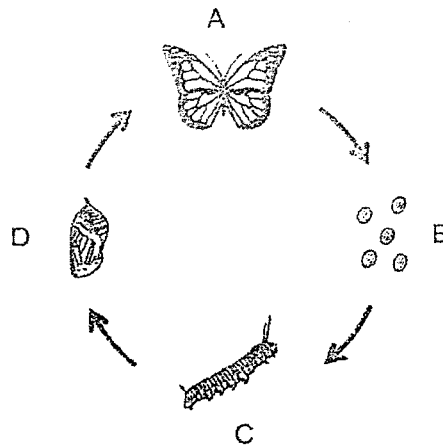

The diagram below shows the change in a leaf.

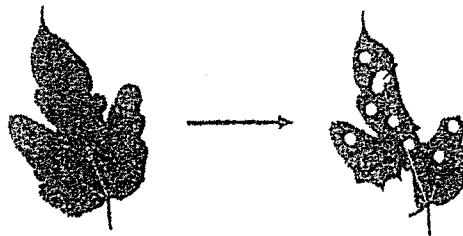

Which stage of the life cycle of the animal, A, B, C or D, had most likely caused the change in the leaf?

- (1) A
- (2) B
- (3) C
- (4) D

4. Study the two groups of animals, A and B, below.

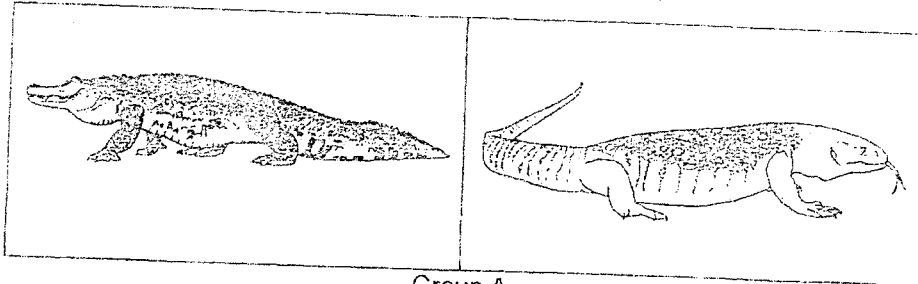

Group A

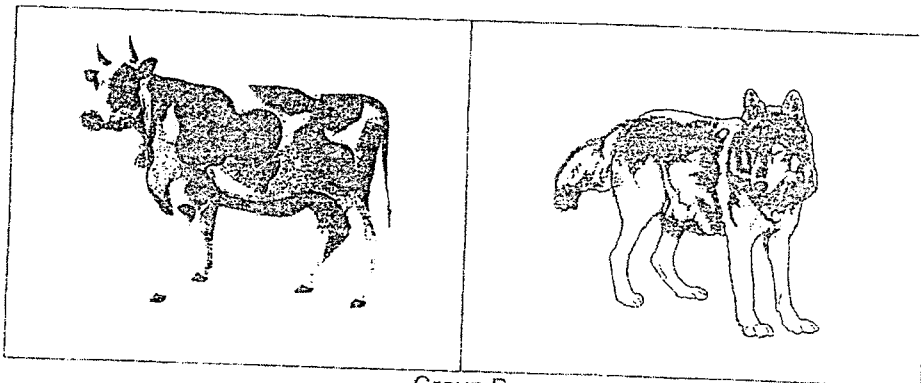

Group B

Which of the following describes the animals in groups A and B correctly?

	Group A		Group B	
	Covered with scales	Give birth to young	Covered with scales	Give birth to young
(1)	No	No	No	Yes
(2)	Yes	No	No	Yes
(3)	No	No	Yes	Yes
(4)	Yes	Yes	No	No

5. The figure below shows different body systems of the human body.

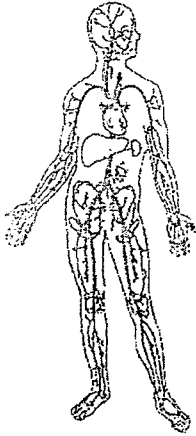

A



B

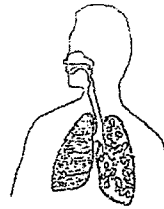

C



D

Which two systems work together to create movement?

- (1) A and B
- (2) A and D
- (3) B and C
- (4) B and D

6. Four students, A, B, C and D, made the following statements about the main functions of part X found in a young plant as shown below.

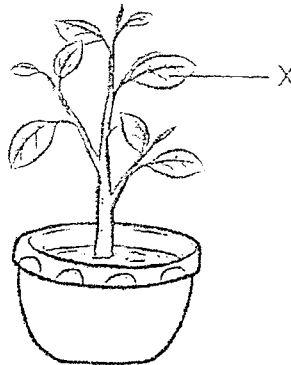

Student	Statement
A	It makes food for the plant.
B	It supports the branches and the leaves.
C	It takes in water and mineral salts from the soil.
D	It holds the plant firmly to the soil.

Which student(s) made the correct statement(s)?

- (1) A only
- (2) C only
- (3) A and C
- (4) B and D

7. Sunny kept animal M in a glass tank with a sealed cardboard cover to prevent it from escaping. He gave the animal M some food and water as shown in the diagram below.

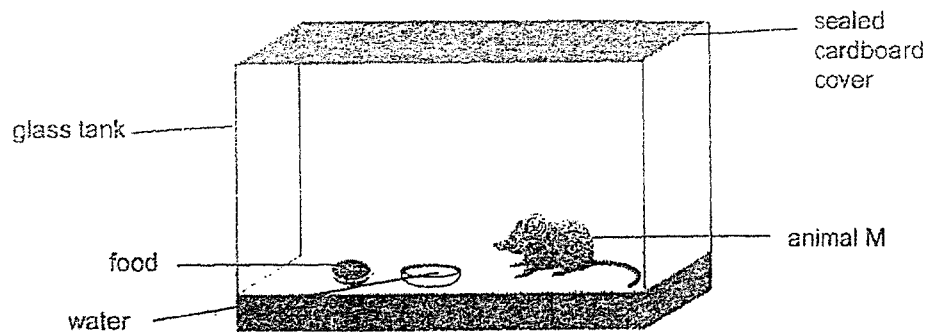

Sunny observed that animal M died after 6 hours.

Which of the following should he do to ensure that the animal M can survive for a longer period?

- (1) Provide animal M with more food.
- (2) Provide animal M with more water.
- (3) Make some holes in the sealed cardboard cover.
- (4) Change the cardboard to a glass cover to allow light to enter the tank.

8. Kim Seng placed four similar slices of bread in four similar containers as shown below. All four containers were closed tightly.

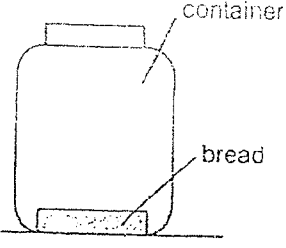
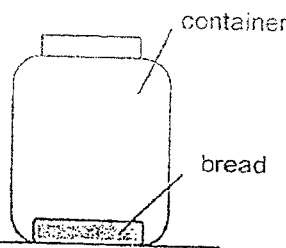
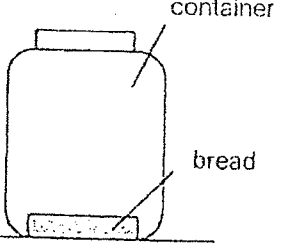
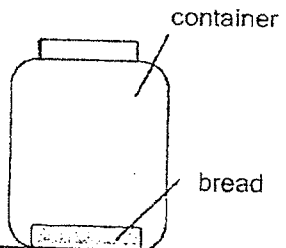
<p style="text-align: center;">set-up A</p> 	<p style="text-align: center;">set-up B</p> 
<p style="text-align: center;">bread sprinkled with 6 drops of water and placed on the table</p>	<p style="text-align: center;">bread sprinkled with 6 drops of water and placed in the refrigerator</p>
<p style="text-align: center;">set-up C</p> 	<p style="text-align: center;">set-up D</p> 
<p style="text-align: center;">bread toasted and placed on the table</p>	<p style="text-align: center;">bread toasted and placed in the refrigerator</p>

In which set-up would fungi grow fastest on its bread?

- (1) A
- (2) B
- (3) C
- (4) D

9. The diagrams show the life cycles of two different animals.

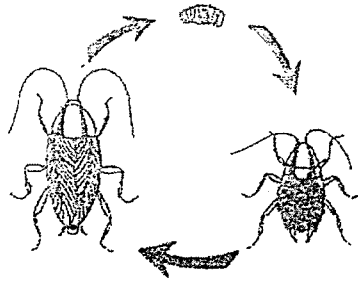

Life cycle of animal X

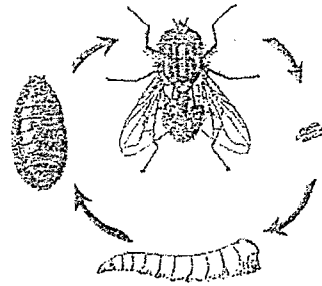

Life cycle of animal Y

Based on the diagrams above, which of the following statements can be observed from the life cycles of the animals?

- A Both animals lay eggs.
 - B Both life cycles have a nymph stage.
 - C The young of animal Y does not resemble its parent.
 - D Animal X has a 3-stage life cycle but animal Y has a 4-stage life cycle.
- (1) D only
- (2) A and C only
- (3) A, C and D only
- (4) A, B, C and D

10. The table below describes the characteristics of the life cycles of four animals, P, Q, R and S.

Characteristic	Animal P	Animal Q	Animal R	Animal S
It has a 4-stage life cycle.	✓	✗	✗	✗
The eggs are laid on land.	✓	✓	✓	✗
The young looks like the adult.	✗	✓	✗	✓

A tick (✓) indicates that the characteristic is correct and a cross (✗) indicates that the characteristic is wrong.

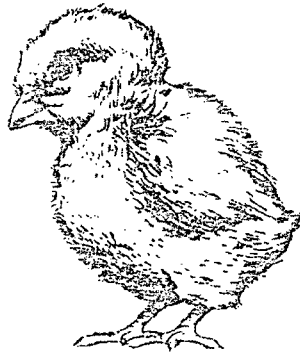

chick

Which of the following animals is likely to be the chick?

- (1) Animal P
- (2) Animal Q
- (3) Animal R
- (4) Animal S

11. The diagram below shows a human digestive system.

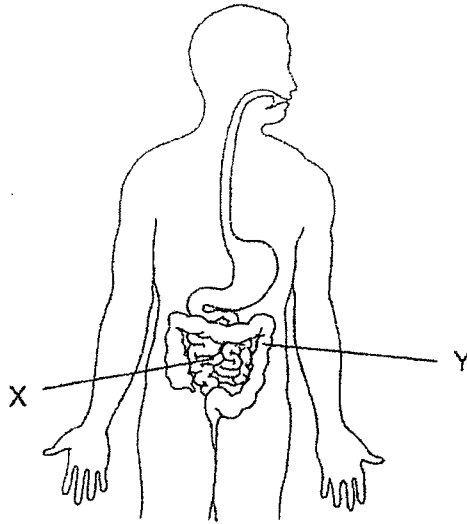

Which of the following statements about X and Y are correct?

- A Water is absorbed in organ Y.
- B Digestion is completed in organ X.
- C Digestion is completed in organ Y.
- D Digested food is absorbed into the bloodstream in organ X.

- (1) A and C only
- (2) A and D only
- (3) B and D only
- (4) A, B and D only

12. The classification table below shows the various systems in the human body and their functions.

System	P	Q	Digestive
Function	Protects the organs in the body.	Carries waste materials away from different parts of the body.	S
	Gives the body its shape.	R	

Some information was left out.

Which of the following sets best represents the letter P, Q, R and S?

	P	Q	R	S
(1)	Skeletal	Respiratory	Removes carbon dioxide from the body.	Breaks down food into simpler substances.
(2)	Muscular	Respiratory	Takes oxygen into the body.	Carries food, water and oxygen to all parts of the body.
(3)	Skeletal	Circulatory	Carries food, water and oxygen to all parts of the body.	Absorbs digested food so that it can be used by the body.
(4)	Muscular	Circulatory	Takes oxygen into the body.	Breaks down food into simple substances.

13. What do solids, liquids and gases have in common?

- (1) They have mass and occupy space.
- (2) They occupy space and have no mass.
- (3) They have definite shape and definite volume.
- (4) They have definite volume but no definite shape.

14. The following flow chart is used to classify three substances, A, B and C.

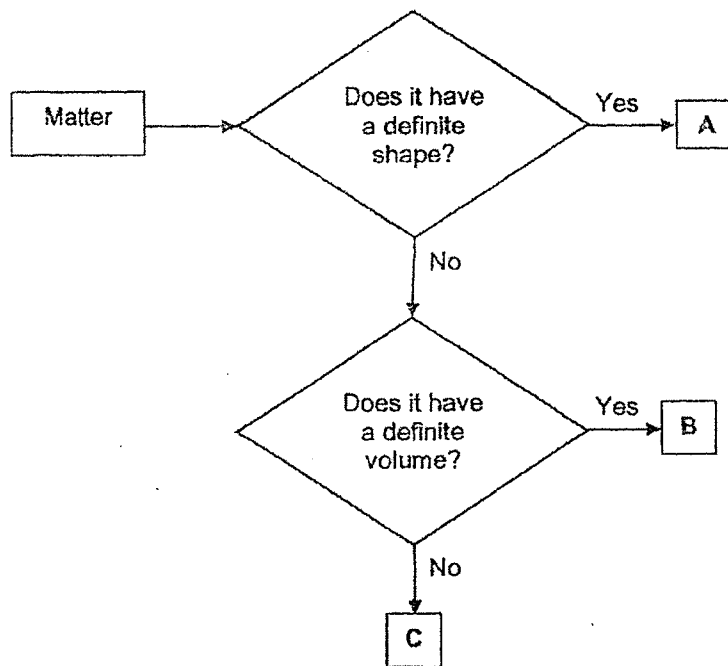

Based on the information given, which one of the following is likely to be substances A, B and C?

	A	B	C
(1)	sand	air	honey
(2)	oil	sand	ice
(3)	sand	honey	air
(4)	ice	air	oil

P4 SA1 SC 2022

15. The diagram below shows part of a pavement with gaps.

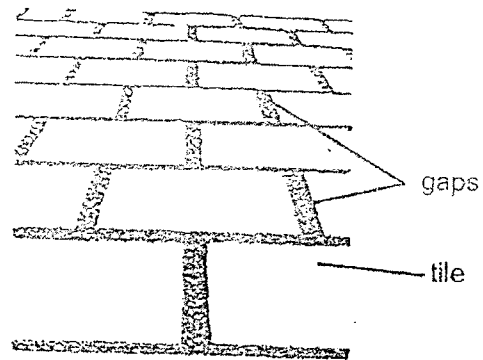

What will happen to the size of tiles and gaps on the pavement on a very hot day?

		Size of	
		tiles	gaps
(1)	increase	increase	increase
(2)	increase	decrease	decrease
(3)	decrease	decrease	decrease
(4)	decrease	increase	increase

16. Wood is used to build houses as shown below.

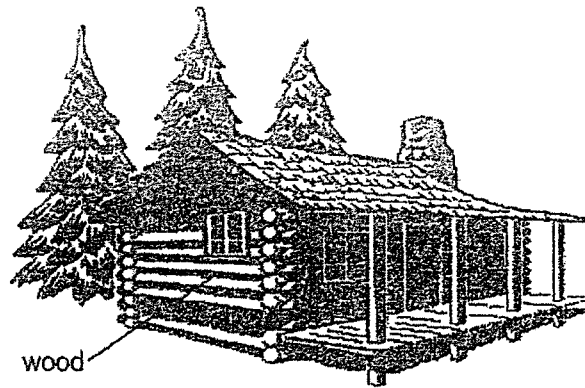

Houses built using wood can withstand wind and heavy rain.

Why is this so?

- (1) Wood is strong.
- (2) Wood is flexible.
- (3) Wood is able to float.
- (4) Wood does not allow light to pass through.

17. Tom stroked two similar iron rods, A and B, with the same magnet as shown below.

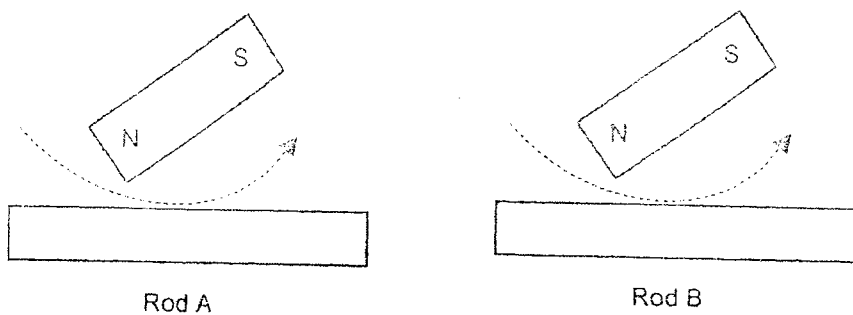

Both rods became magnets. Rod A attracted more pins than rod B.

Which of the following shows the possible number of strokes used for rods A and B respectively?

	Rod A	Rod B
(1)	40	40
(2)	40	15
(3)	15	40
(4)	15	15

18. Mrs Lim conducted an experiment using the set-up as shown below.

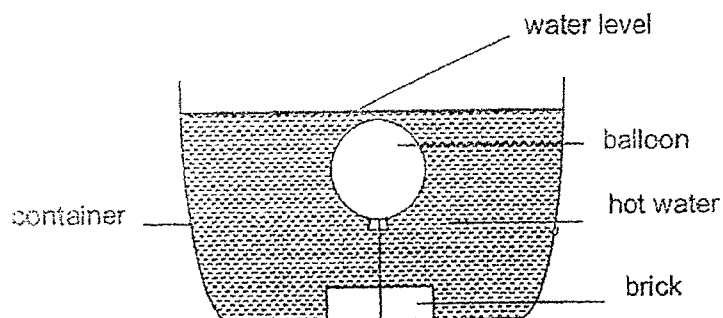

After some time, she observed that both the size of the balloon and the water level in the container increased.

Which one of the following explains why the water level in the container increased?

- (1) The balloon expanded and increased in mass.
- (2) The hot water expanded and occupied more space.
- (3) The hot water increased in mass and occupied more space.
- (4) The air in the balloon expanded and occupied more space in water.

19. The diagram below shows a tent.

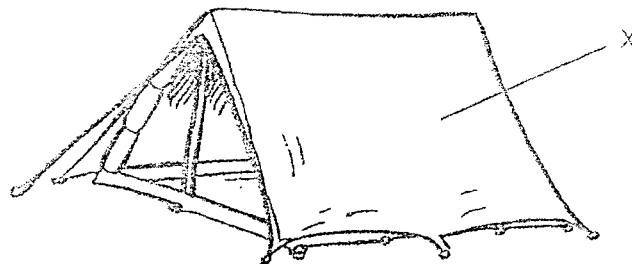

Study the properties of the four materials shown below.

Material	Properties of material		
	Waterproof	Flexible	Strong
A	✓		✓
B	✓	✓	✓
C	✓	✓	
D		✓	✓

Which material is most suitable for making part X of the tent?

- (1) A
- (2) B
- (3) C
- (4) D

20. Jenny conducted an experiment on four different materials, A, B, C and D. The materials are of the same size and mass.

Jenny measured the mass of each material before placing each one of them in a container of water. She measured the mass of each material immediately after removing them from the container.

She recorded her observations in the table shown below.

Material	Mass <u>before</u> placing in the container (g)	Mass <u>after</u> removing from the container (g)
A	130	320
B	130	250
C	130	220
D	130	190

Based on Jenny's results, which material, A, B, C or D, is most suitable to make a bath towel?

- (1) A
- (2) B
- (3) C
- (4) D

21. Two ring magnets and a copper ring are slotted in a wooden stand as shown below.

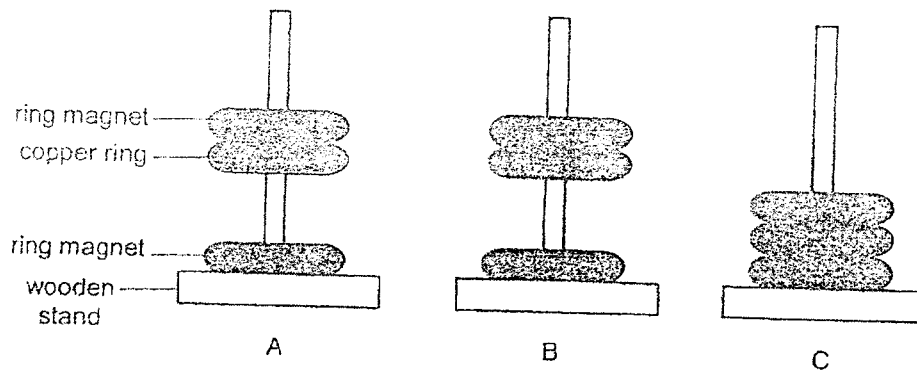

Which of the following observations below is / are possible?

- (1) B only
- (2) A and B only
- (3) B and C only
- (4) A, B and C only

22. Bar magnets are arranged as shown below.

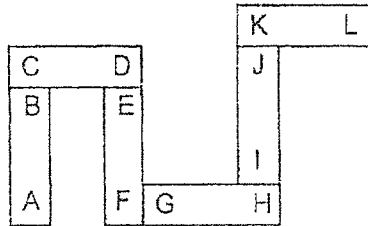

The bar magnets were then re-arranged with an iron bar added. Which of the following arrangements shown below is possible?

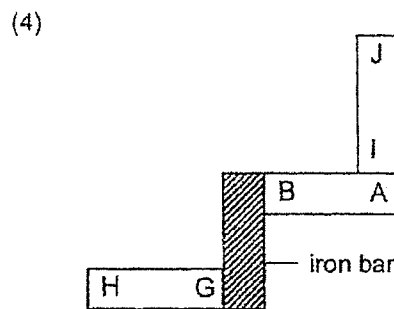
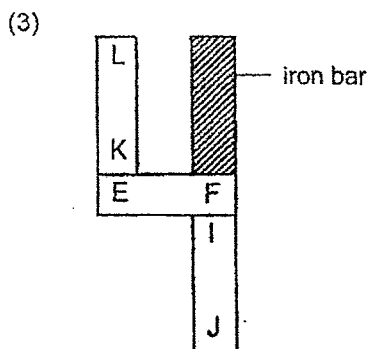
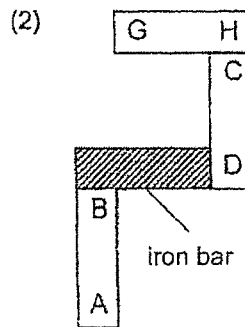
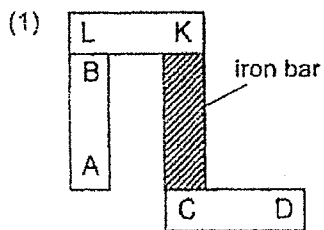

23. The diagram below shows a 500 cm^3 jar containing 200 cm^3 of water and a pump containing 150 cm^3 of air. When the plunger is pushed all the way down, the air in the pump goes into the jar.

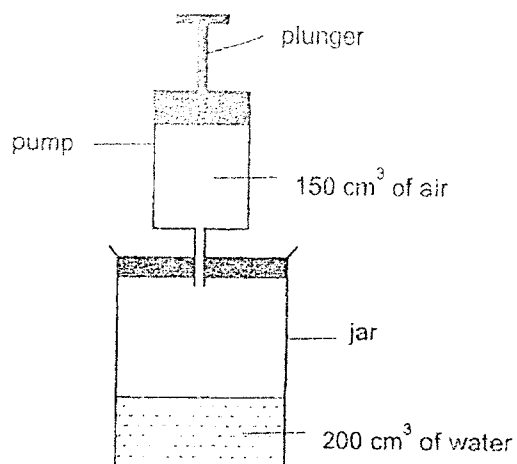

What is the amount of space occupied by air in the jar after the plunger is pushed down?

- (1) 150 cm^3
- (2) 300 cm^3
- (3) 450 cm^3
- (4) 500 cm^3

24. Bala lowered an inverted clear plastic cup with a hole at its base into the water with a ping pong ball floating on it.

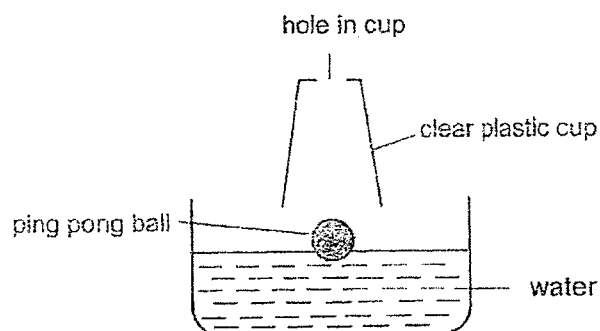

Which of the following shows the correct observation that Bala would make and the reason for the observation?

	Observation	Reason
(1)		The cup is filled with air and thus water cannot enter.
(2)		The cup is filled with air. As air can be compressed, some water can enter the cup.
(3)		Water enters the cup and occupies the space as air has escaped. The ping pong ball will float on water as it is filled with air.
(4)		Water enters the cup and occupies the space as air has escaped. The ping pong ball will sink in water as it is filled with air.

25. Jimmy placed objects A and B on a balance and it tilted as shown in the diagram below.

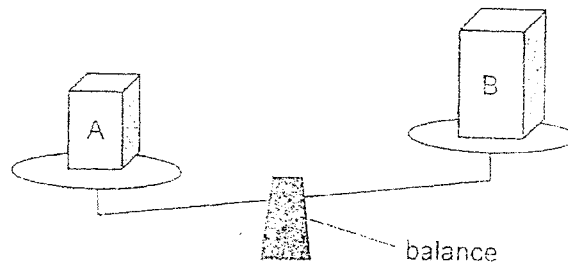

He then repeated the experiment by placing objects A and C on the balance and it tilted as shown in the diagram below.

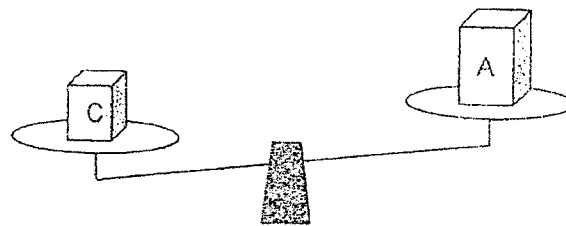

Which of the following statements is not correct?

- (1) Object C is the heaviest.
- (2) Object B is the lightest.
- (3) Object B has the largest volume.
- (4) Objects B and C have the same volume.

26. Joo Seng conducted an experiment using two similar glass beakers.

In set-up X, he wrapped the glass beaker with material A.

In set-up Y, he wrapped the glass beaker with material B. He filled both beakers with the same volume of hot water at 80°C .

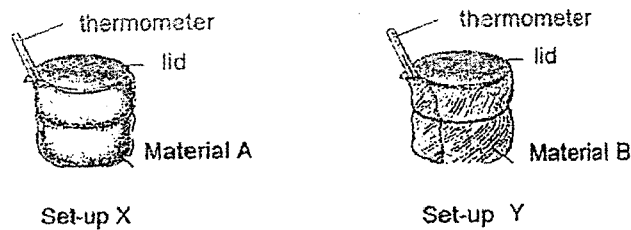

The graph shows the temperature in both set-ups over 15 minutes.

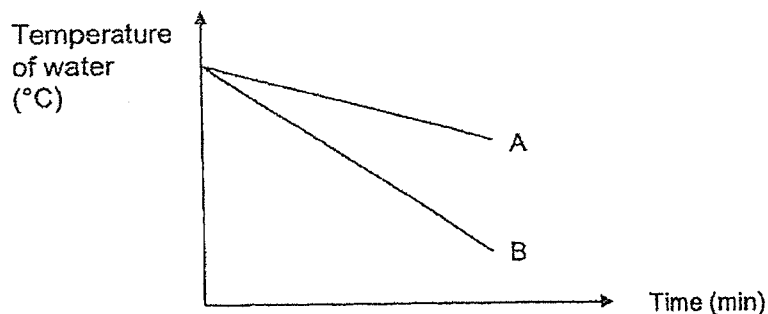

Which one of the following describes the use of material A or B correctly?

- (1) Material A can be used to make an ice box to keep ice for a longer period of time.
- (2) Material A can be used to make a cooking pot as it is a better conductor of heat.
- (3) Material B can be used to make the handle of a cooking pot as it is a poorer conductor of heat.
- (4) Material B can be used to make a lunchbox as it can keep food warmer for a longer period of time.

27. Jack entered a room with an air-conditioner which was already switched on as shown in the diagram below. After a few minutes, he felt very cold.

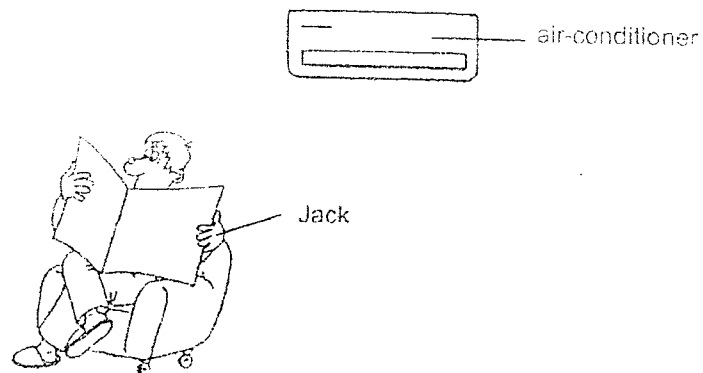

Which one of the following correctly explained why Jack felt cold?

- (1) Jack lost heat to the cold air in the air-conditioned room.
- (2) The cold air in the air-conditioned room lost heat to Jack.
- (3) Jack gained heat from the cold air in the air-conditioned room.
- (4) Jack gained heat from the warm air in the air-conditioned room.

28. Mary prepared the set-up shown below using the same amount of wax to hold the identical thumbtacks on the materials A and B respectively.
- The materials have similar length and the thumbtacks were placed at equal distance away from the heat source. Mary observed the thumbtack on material B drop off first.

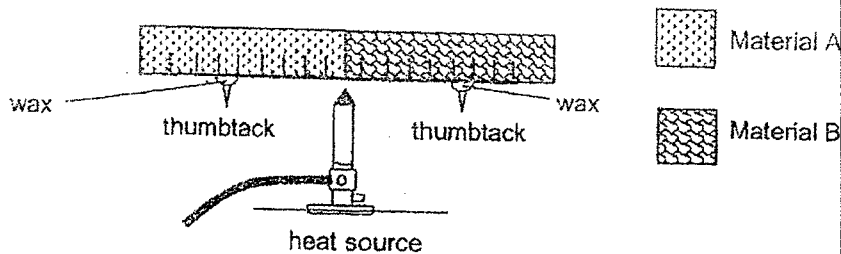

Next, she wrapped a piece of paper round materials A and B as shown below and put over a heat source. She observed the piece of paper after three minutes.

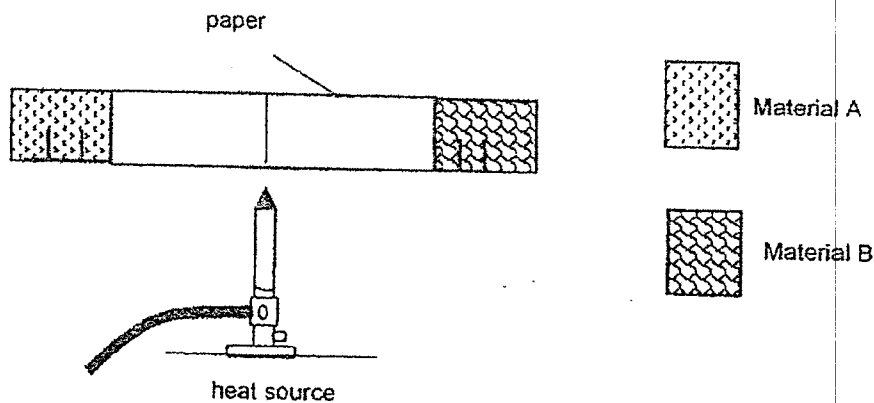

Which of the following provides the correct observation and explanation?

	Observation	Explanation
(1)	The paper on material A would burn.	Material A conducted heat to the paper more quickly.
(2)	The paper on material A would burn.	Material A conducted heat away from the paper more slowly.
(3)	The paper on material B would burn.	Material B conducted heat to the paper more quickly.
(4)	The paper on material B would burn.	Material B conducted heat away from the paper more slowly.

End of Booklet A

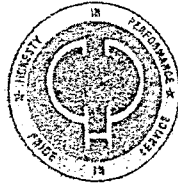

HENRY PARK PRIMARY SCHOOL
SEMESTRAL ASSESSMENT 1 2022
PRIMARY 4
SCIENCE
SECTION B (44 MARKS)

INSTRUCTIONS TO CANDIDATES

1. Do not turn over this page until you are told to do so.
2. Follow all instructions carefully.
3. Answer all questions.

Name: _____ ()

Class: Primary 4 ()

Date: 12 May 2022

Total Time for Booklets A and B: 1 h 45 min

Marks for Section B: _____

Section B (44 marks)

For questions 29 to 40, write your answers in the space provided.

The number of marks available is shown in brackets [] at the end of each question or part question.

29. The diagram shows how some substances are transported in the human body to provide energy for the arms to bend.

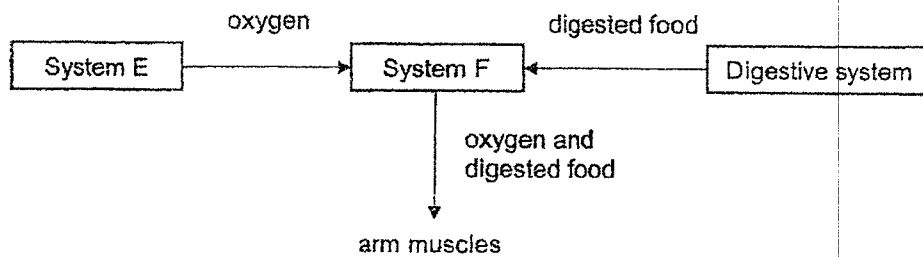

- (a) Based on the information given, identify systems E and F. [2]

(i) System E: _____ system

(ii) System F: _____ system

- (b) Name an organ that can be found in system E. [1]

- (c) State the function of the stomach in the digestive system. [1]



30 (a) Why do living things reproduce?

[1]

Study the flow chart shown below.

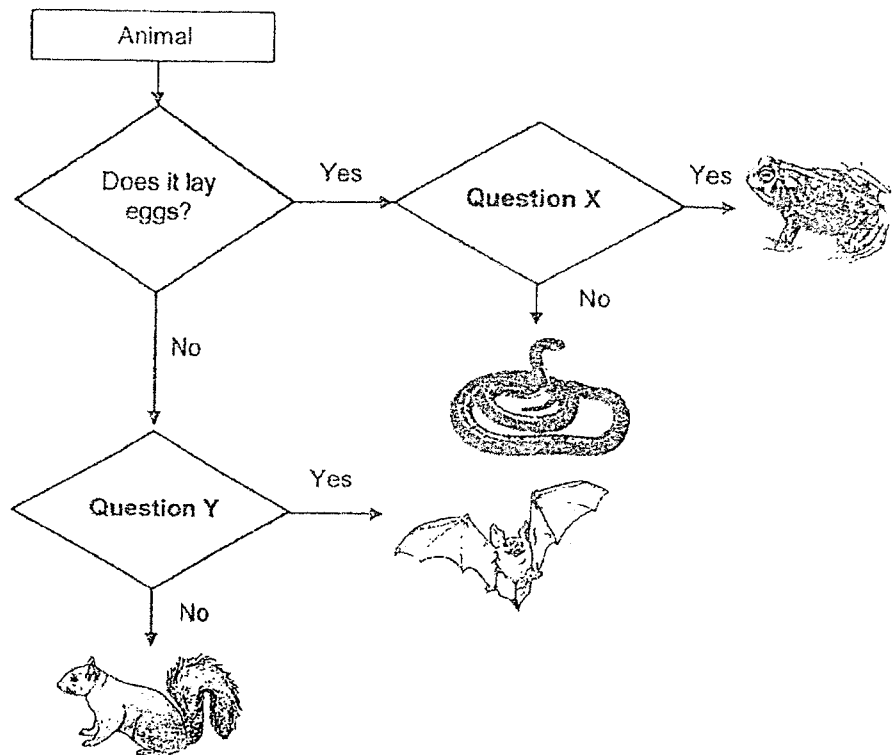

(b) Based on the diagram given, write down a possible question for X and Y. [2]

Question X: _____

Question Y: _____

(c) Name two physical characteristics that would confirm that an animal is an insect. [1]

(i) _____

(ii) _____



31. The graph shows the changes in the amount of digested and undigested food as it moved through the different organs, P, Q, R, S, and T of the human digestive system.

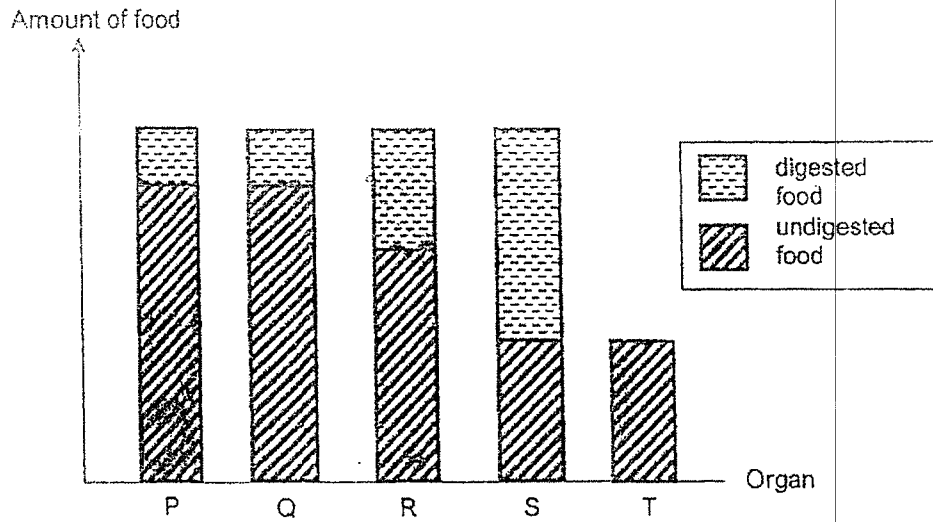

- (a) Name organ P. [1]

- (b) Based on the graph, state whether digestion occurs in organ Q. [2]
Give a reason for your answer.

- (c) Explain how the graph shows that organ S has absorbed the digested food. [1]



32. Dengue fever is spread by the Aedes mosquito.
 In town Z, the number of dengue cases is affected by the amount of rainfall as shown in the graphs below.

Graph 1: Amount of rainfall

Amount of rainfall (unit)

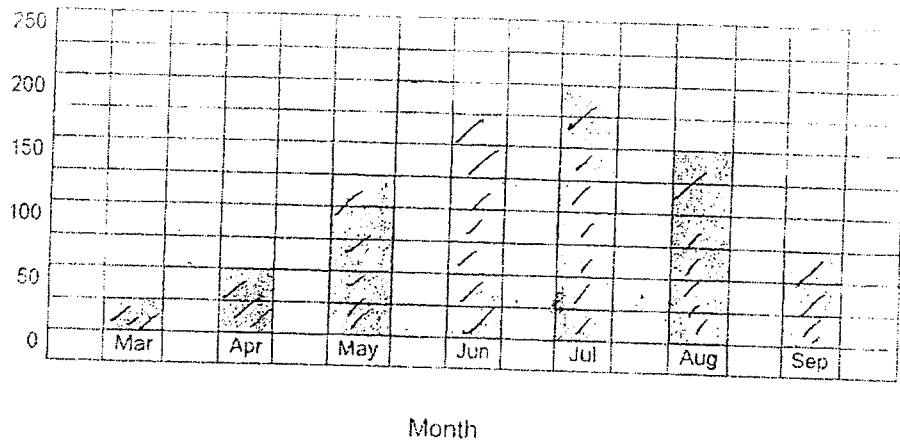

Graph 2: Number of Dengue cases

Number of dengue cases

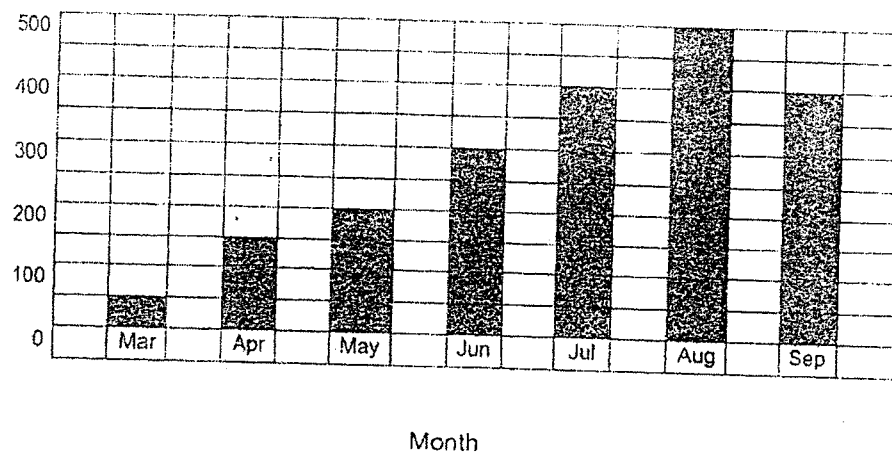

- (a) What is the relationship between the amount of rainfall and the number of dengue cases from March to July?

[1]



Question 32 continued

- (b) Give a reason for your answer in (a).

[1]

The diagram shows the stages in the lifecycle of the Aedes mosquito.

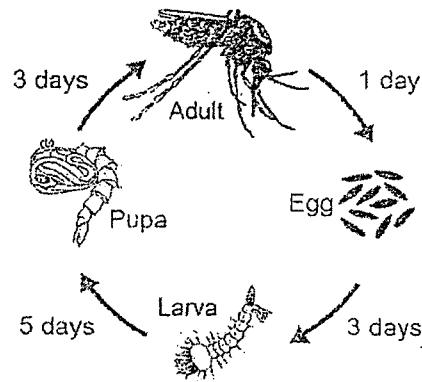

- (c) Based on the information given, how many days does it take for the mosquito to reach adult stage after the eggs are hatched? [1]

The number of dengue cases takes about three to four weeks to change after the amount of rainfall changes.

Dengue fever starts to develop about two weeks after a person is bitten by Aedes mosquito.

- (d) Based on the information given, suggest another reason why the number of dengue cases does not change immediately after the amount of rainfall changes. [1]



33. Alvin set up an experiment as shown below to compare the flexibility of three similar strips, A, B, and C, each made of a different material.

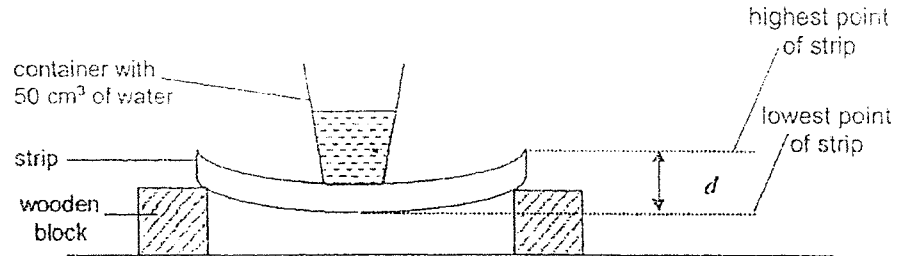

For each strip, he added 50 cm³ of water into the container and measured the distance d . The distance, d , between the highest and lowest points of the strip was measured. His results are shown below.

Strip	Amount of water added into the container (cm ³)	d (mm)
A	50	29
B	50	37
C	50	8

The diagram shows part of a bookshelf.

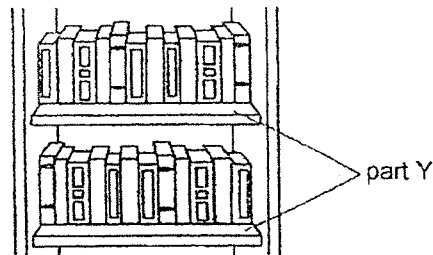

Based on the results given, which strip, A, B or C, is the most suitable for making part Y in the diagram shown above? [2]

Explain your answer.



34. Peter made three electromagnets using rods A, B and C, each of the same length. The rods are made of different materials.

He then placed the electromagnet at one end of a ruler and slowly pushed the paper clip towards it from the other end of the ruler until the paper clip was attracted to the rod as shown in the diagram below.

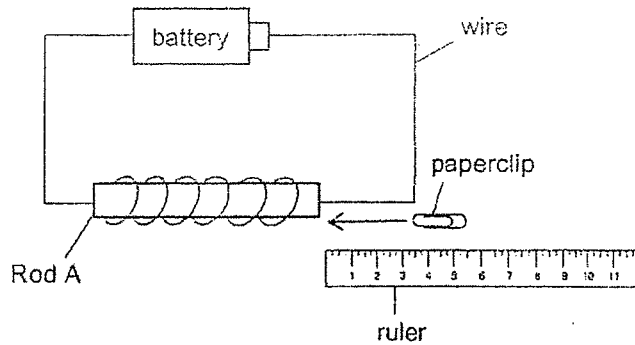

He repeated the experiment with rods B and C. The table shows the results of Peter's experiment.

Rod	Distance at which the paper clip was attracted to the electromagnet (cm)
A	5
B	9
C	0

- (a) Which one of the rods was the strongest electromagnet? Give a reason for your answer. [1]

- (b) Peter noticed that rod C did not attract the paper clip at all. Explain why this is so. [1]

- (c) Without removing any part of the set-up, state one way to increase the strength of the electromagnet. [1]



35. Tim sealed the opening of a syringe before filling the syringe completely with substance X. He then put weights on the plunger of the syringe as shown below.

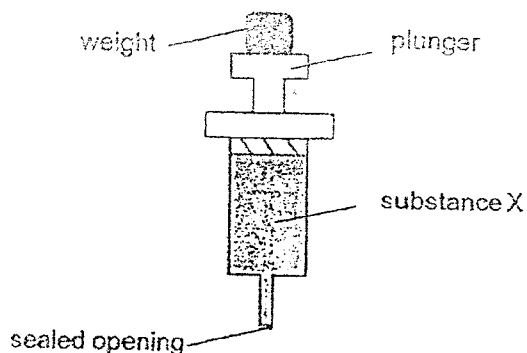

He recorded the volume of substance X in the table below for every weight added on the plunger.

weight added (g)	volume of substance X (cm ³)
0	100
1	88
2	80
3	74

- (a) What is the volume of substance X before the weights were added? [1]

- (b) What happened to the volume of substance X when the number of weights added increased? [1]

- (c) Based on the results of the experiment, what can Tim conclude about the property of substance X? [1]

- (d) Suggest a reason why Tim needed to seal the opening of the syringe before conducting the experiment. [1]



36. Mary was trying to empty a tin of milk into a container. The milk was dripping slowly.

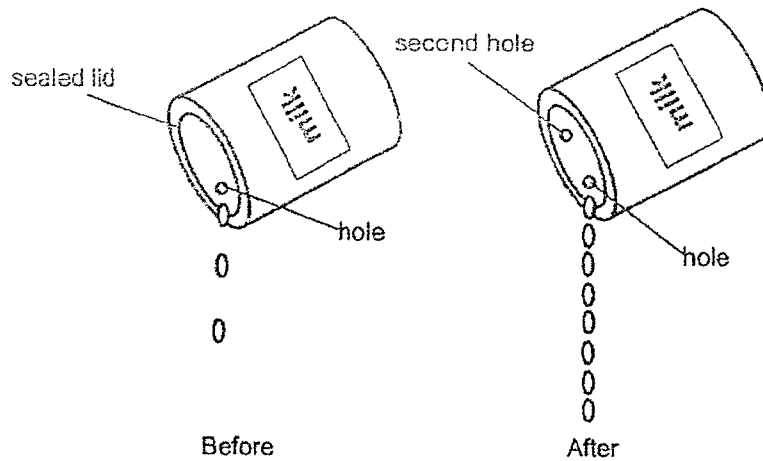

Mary made a second hole on the sealed lid as shown in the diagram above.

(a) Milk dripped more quickly when there were two holes on the lid.

Explain why.

[2]

(b) After pouring out all the milk from the tin, was the tin empty?

[2]

Give a reason for your answer.



37(a) State what temperature is.

[1]

Jane put some noodles and fish balls at room temperature into a pot of boiling soup as shown in the diagram.

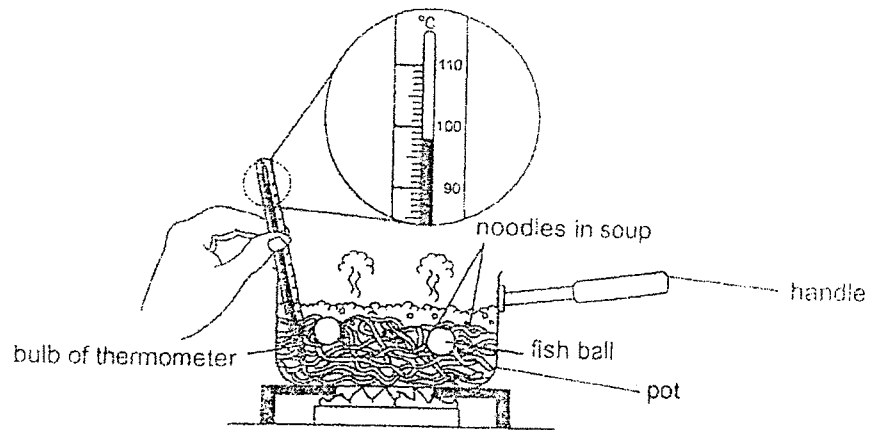

(b) After Jane added some fish balls, the temperature of the soup decreased. Explain why

[1]

(c) What are the suitable materials that can be used to make the handle of the pot and the pot?
Tick (✓) the suitable material for the different parts of the pot.

[2]

	Material	
	Poor conductor of heat	Good conductor of heat
(i) Pot		
(ii) Handle of pot		



38. Mr Ang took a glass jar of jam from the refrigerator. He tried to open it but was unsuccessful.

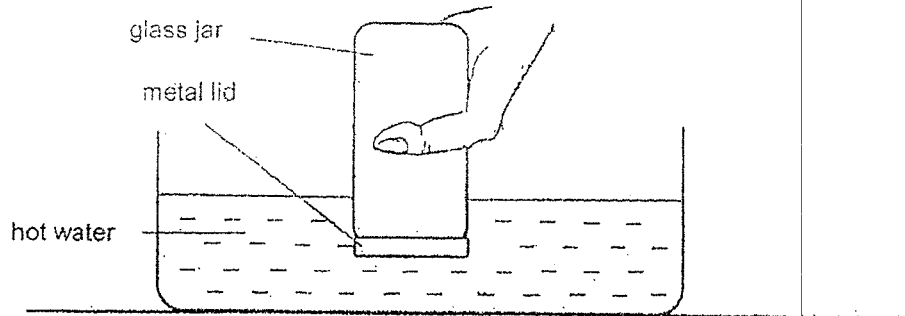

His father told him to turn the jar over and dip it into a basin of hot water for twenty seconds as shown in the diagram above. After that, he was able to open the lid.

(a) Explain why Mr Ang was able to open the lid of the jam jar.

[2]

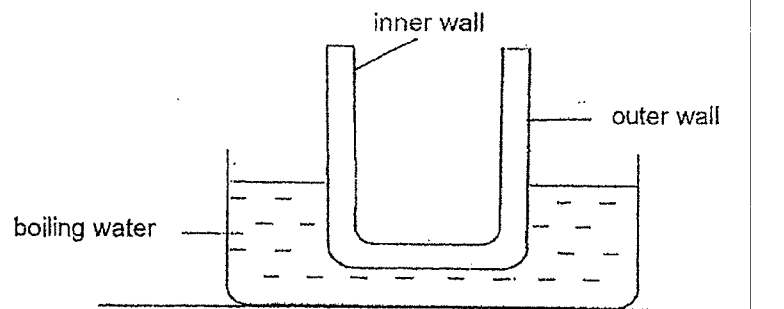

Thick-walled glass

(b) Mr Ang took out a cold thick-walled glass from the refrigerator and placed it into a basin of boiling water as shown above. When he placed the glass in the boiling water, the glass started to crack.

[2]

Explain why the glass cracked.



39. May wanted to find out which material is able to keep her coffee hot for a very long time.

She used three similar cups and wrapped each one with a different material as shown below. She also poured the same amount of hot coffee into each cup.

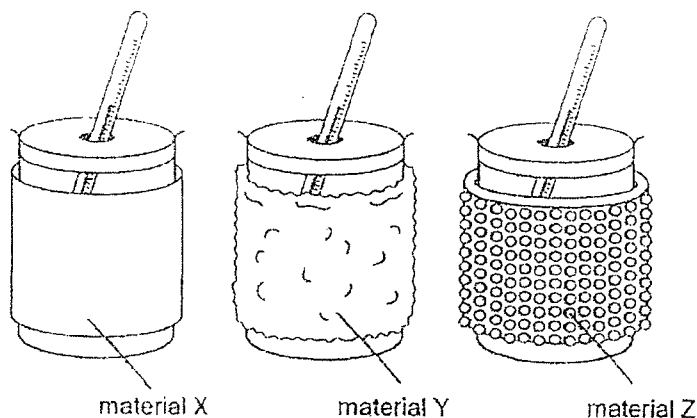

She measured the temperature of the hot coffee in each cup using a thermometer. The temperature was measured every five minutes and recorded in a table shown below.

Material wrapped around the cup	Temperature of coffee (°C)				
	At the start	5 min	10 min	15 min	20 min
X	60	55	43	39	29
Y	60	59	51	49	45
Z	60	57	46	43	39

(a) Based on the results, which material, X, Y or Z will keep the coffee hot for the longest period of time? [1]

(b) Explain your answer in (a). [2]



40. Mrs Lee took a plate from the kitchen cabinet and placed a fish taken out from the refrigerator on it as shown in the diagram below.

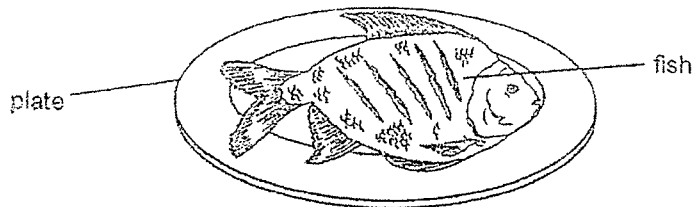

- (a) Put a tick (✓) in the boxes below to indicate if the plate and fish would gain or lose heat when the fish was placed on the plate. [1]

	gained heat	lost heat
Plate		
Fish		

- (b) Explain why Mrs Lee's hand felt cold when she touched the plate after two minutes. [1]

- (c) Mrs Lee then removed the fish from the plate and left the plate on a table in the kitchen. [2]

Describe how the temperature of the plate would change over a period of 2 hours.

End of Booklet B



P4 Science SA 1 – Corrections Sheet

Name: _____

Section A													
Q1	1	Q5	4	Q9	3	Q13	1	Q17	2	Q21	3	Q25	4
Q2	3	Q6	1	Q10	2	Q14	3	Q18	4	Q22	2	Q26	1
Q3	3	Q7	3	Q11	4	Q15	2	Q19	2	Q23	2	Q27	1
Q4	2	Q8	1	Q12	3	Q16	1	Q20	1	Q24	3	Q28	2
Qn	Answer						Do your corrections here						
29	(a) (i) respiratory (ii) circulatory (b) nose / windpipe / lungs (c) To break food down into simpler substances												
30	(a) Living things reproduce to ensure continuity of their kind / species <u>OR</u> prevent extinction of their kind / species. (b) Question X: Does it have moist skin? Question Y: Does it have wings? (c) 3 body parts 3 pairs of legs												
31	(a) Mouth (b) There is no digestion in organ Q. The amount of digested food remains the same as organ P. (c) Organ T does not contain digested food.												
32	(a) As the amount of rainfall increases, the number of dengue cases also increases. (b) More rainfall leads to more stagnant waters for mosquitoes to lay eggs so there is more Aedes mosquitoes. (c) 8 days (d) It takes time for the young of the Aedes mosquitoes to reach adult stage.												
33	Strip C. The distance d is the shortest. C is the least flexible / bends the least so the books will not fall off.												

34	<p>(a) Rod B. It attracted the paper clip at the longest distance.</p> <p>(b) Rod C is made of a non-magnetic material so it cannot be magnetised.</p> <p>(c) Increase the number of coils around the rod <u>or</u> increase the number of batteries.</p>										
35	<p>(a) 100cm^3</p> <p>(b) The volume of substance X decreases.</p> <p>(c) Substance X can be compressed.</p> <p>(d) To prevent substance X from escaping.</p>										
36	<p>(a) The extra hole will allow air to enter the can. Air will take up space in the tin, pushing the milk out from the other hole.</p> <p>(b) No, there is still air in the can.</p>										
37	<p>(a) Temperature is a measure of how hot or cold an object is.</p> <p>(b) The soup lost heat to the fish ball.</p> <p>(c) Pot – good conductor of heat handle of pot – poor conductor of heat</p>										
38	<p>(a) The metal lid gained heat from the hot water faster and expanded more than the glass.</p> <p>(b) The outer wall (of the glass) was in contact with the boiling water but not the inner wall so the outer wall gained heat faster and expanded faster than the inner wall.</p>										
39	<p>(a) Material Y</p> <p>(b) The temperature of the hot coffee decreased the slowest. Material Y conducted heat from the hot coffee to the surrounding air the slowest.</p>										
40	<table border="1" data-bbox="347 1570 898 1749"> <thead> <tr> <th>(a)</th> <th>gained heat</th> <th>lost heat</th> </tr> </thead> <tbody> <tr> <td>Plate</td> <td></td> <td>✓</td> </tr> <tr> <td>Fish</td> <td>✓</td> <td></td> </tr> </tbody> </table> <p>(b) Mrs Lee's hand lost heat to the cold plate.</p> <p>(c) The plate gained heat from the surrounding air and the temperature of the plate would increase <u>until</u> it reached the room temperature.</p>	(a)	gained heat	lost heat	Plate		✓	Fish	✓		
(a)	gained heat	lost heat									
Plate		✓									
Fish	✓										